



Stairs



One and Two Family Residential Dwellings

- Information related to permit and inspection requirements

This brochure describes the code requirements for new residential stairs. Each situation has unique conditions, so please call or visit the Development Services Center with any questions.

Project	Requirement
Existing stairway that leads to existing finished living space that was created with a building permit (Verify prior permits at the Development Services Center)	<i>Vested project</i> – no changes are required
Existing stairway that leads to existing unfinished space (basement, attic or garage) that you plan to convert to living space	May be allowed to remain without changes if it meets the alternative requirements in our brochure <i>Converting Attics, Basements or Garages to Living Space</i>
Build a new stairway	Building permit and inspections to current Code

Stair width

- New stairways must be at least 36 inches wide from wall to wall above the handrail (except spiral stairs which must be at least 26 inches wide from center post to outside edge of tread).

Risers and treads

- If you are building a new standard residential stairway (not a spiral), each step (or riser) can't be more than 8 inches high.
- Treads are the flat surfaces that you step onto. For new stairs, the treads have to be a minimum of 9 inches deep from front to back (not counting the part underneath the nosing of the tread above). The exposed edge of the tread is called the nosing, and the nosing must stick out at least 3/4 inches, but not more than 1 1/4 inches.
- The steps in a flight of stairs have to be even so that people don't trip. The code allows only 3/8 inch difference between the largest and the smallest rise, and only 3/8 inch difference between the largest and smallest tread measured from front to back.

Headroom

- Headroom is the distance, measured vertically (plumb, straight up and down), between the ceiling or any projection from the ceiling, such as a beam, and a sloped line formed by placing a straight-edge along the nose of the stair treads.
- New stairs must have headroom of at least 6 feet 8 inches (except spiral stairs which may have headroom of 6 feet 6 inches).

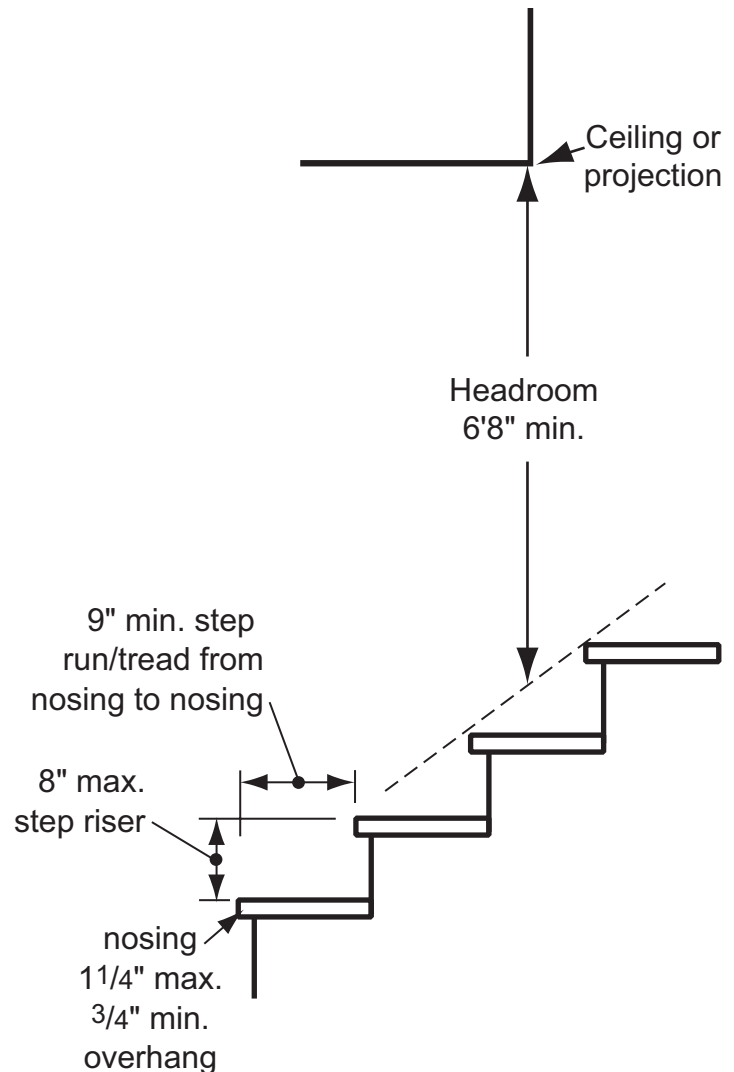

Winder stairs

- Stairways that turn a corner, with treads that are narrow on one end and wider at the other, are called winder stairs. You may build winder stairs, but the treads must be at least 6 inches deep at their narrowest point. Also, all of your treads must be at least nine inches wide, measured 12 inches from where they are the narrowest.
- Although the tread size varies on winder stairs, there still may not be more than $\frac{3}{8}$ inch variation between the largest and smallest rise.

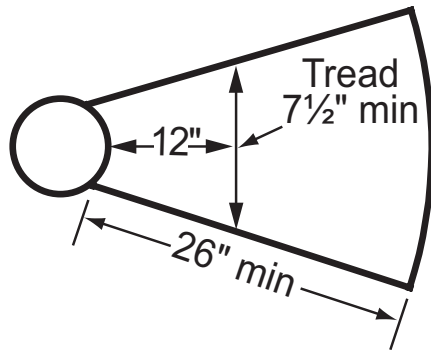
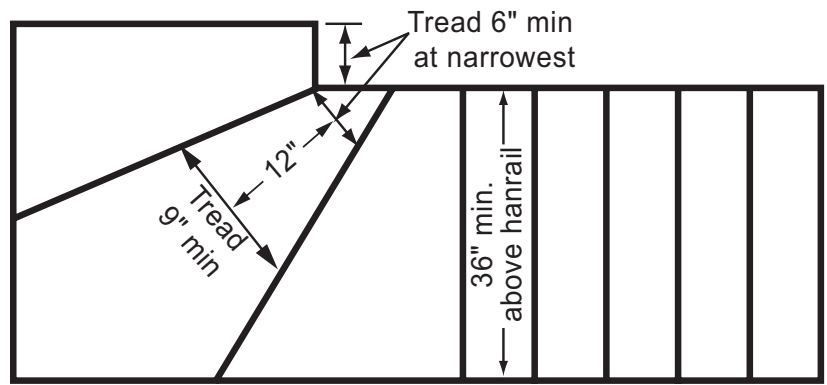

Spiral stairs

- Spiral stairway treads must be at least $7\frac{1}{2}$ inches deep measured 12 inches out from where they are the narrowest. The risers can't be more than nine and one half inches high.
- The minimum width of a spiral stairway from the center pole to the outside edge of the tread is 26 inches.
- Each spiral stair tread must be identical.

Landings

- Any exterior entry/exit door must have a landing at least 3' x 3' inside the door before there can be a step. The interior landing must not be more than 1 1/2 inches lower than the top of the threshold. On the outside of the door, the step down may be eight inches before you need another 3' x 3' minimum landing, providing the door does not swing over the stairs. After the landing there may be additional steps.

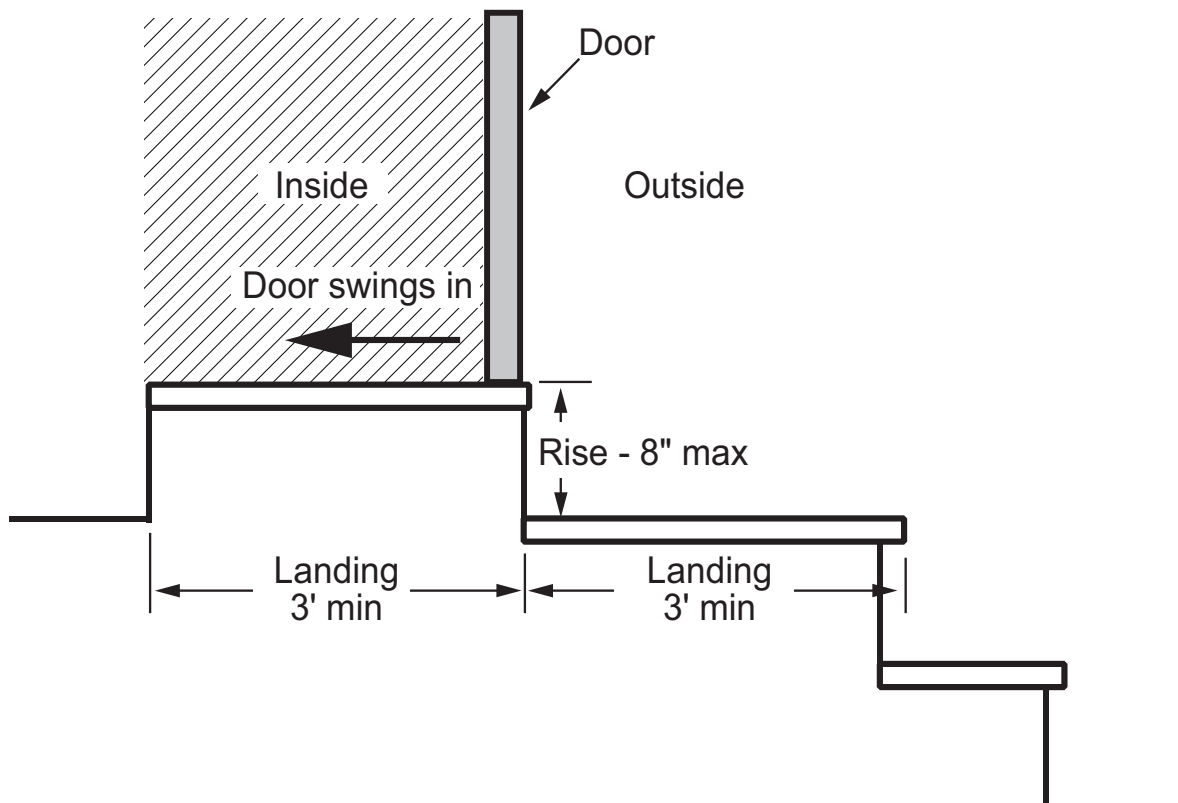

Handrails

- Stairways must have a handrail if the stairway has more than three risers.
- Handrails may project over stairs by 4 1/2 inches maximum on each side of the stairway.
- Handrails must be continuous for the full length of the stairs. They must turn back into the wall or butt into a post so that purse straps and clothing won't get caught behind them and cause a fall.
- Handrails attached to the wall must have a space between the wall and the rail of at least 1 1/2 inches to provide a grippable surface.
- Handrails on the open side of a stairway must meet guardrail requirements.
- The height of handrails is measured straight up from the nosing of the treads to the top of the handrail. A handrail along a wall must be between 30 inches and 38 inches high.
- A round handrail must have a diameter no smaller than 1 1/4 inches and no larger than 2 inches, so that it can be easily and securely gripped. Other handrail shapes are allowed, if the perimeter dimension is at least 4 inches and not more than 6 1/4 inches, with a cross section dimension not more than 2 1/4 inches.

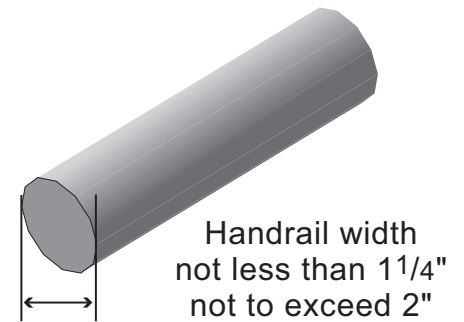
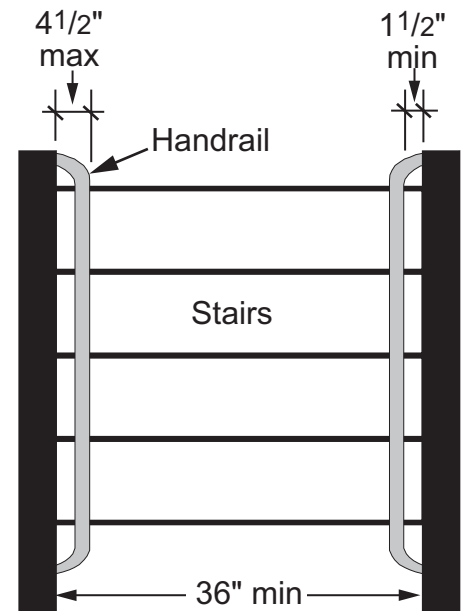

Guardrails

- A guardrail is required to prevent someone falling from a balcony, deck, landing, etc. that is more than 30 inches above the floor or ground below. Guardrails must be at least 36 inches high, except that they may be 34 inches (measured straight up from the nosings) at the open sides of stairways.
- Guardrails on stairs must have some kind of a pattern, so that a 5 inch sphere can't pass through. However, all guardrails along raised floors, landings, porches, decks and balconies must have intermediate rails or ornamental closures that do not allow passage of a 4 inch sphere.
- At the bottom edge of a guardrail along a series of steps, the space between the tread, riser and the guardrail must be small enough to prevent a 6 inch sphere from getting through.

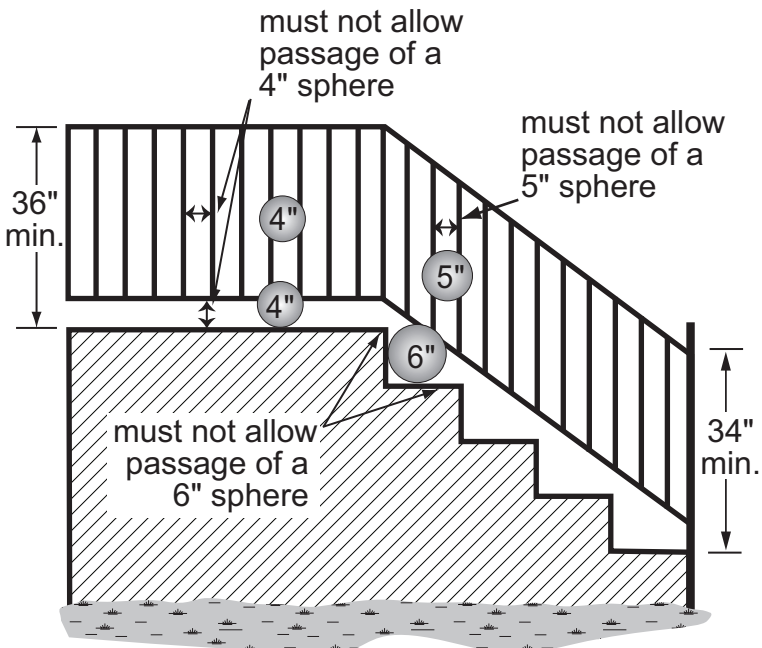

Guardrail with vertical pattern

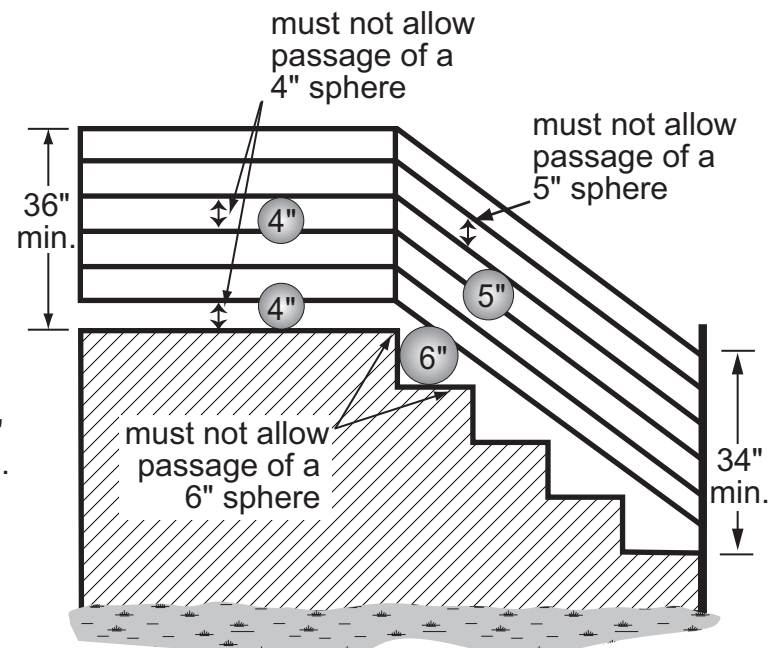

Guardrail with horizontal pattern

Who can do the work

For work that requires a permit, the owner of a single family home or duplex may hire a licensed contractor to do the work, or in some cases, do the work themselves. This means that you, the owner, will be responsible for doing the work; not a friend, neighbor, tenant or relative, unless they hold an appropriate contractor's license. The permit requirements for an owner doing their own work are the same as those for a contractor doing the work.

Scheduling an inspection

- Call 503-823-7000, the BDS 24 hour inspection request line
- Enter your IVR or permit number
- Enter the three-digit inspection code for the type of inspection you are requesting
- Enter a phone number where you can be reached during weekdays and if you want the inspection in the morning or afternoon
- There must be an adult over age 18 to allow the inspector entry

Resources

BDS publishes other handouts that provide helpful information about other residential projects, such as:

- What Plans Do I Need for a Building Permit?
- Converting Attics, Basements and Garages to Living Space
- Fences, Decks and Outdoor Projects

These handouts and others as well as permit applications and code guides are available both in the Development Services Center and on the BDS Web site.

Helpful Information

Bureau of Development Services

City of Portland, Oregon
1900 SW 4th Avenue, Portland, OR 97201
www.portlandoregon.gov/bds

General Office Hours:

Monday through Friday, 8:00 am to 5:00 pm
BDS main number: 503-823-7300

Permit Information is available at the following location:

Development Services Center (First Floor)
For Hours Call 503-823-7310
or visit www.portlandoregon.gov/bds

Permitting Services (Second Floor)

For Hours Call 503-823-7310
or visit www.portlandoregon.gov/bds

Important Telephone Numbers

DSC automated information line	503-823-7310
Building code information	503-823-1456
Planning and Zoning information.....	503-823-7526
Permit information for electrical, mechanical, plumbing, sewer and sign	503-823-7363
Permitting process information	503-823-7357
Permit resources and records	503-823-7660
BDS 24-hour inspection request line requires IVR number and three digit type of inspection code	503-823-7000
Residential information for one and two family dwellings.....	503-823-7388
City of Portland TTY	503-823-6868

Other sources of information to help you

For additional information check out our publications in the DSC and on our Web site. Titles of interest include: Guide to Permits and Inspections for One and Two Family Dwellings, Windows, Stairs and others.

For more detailed information regarding the bureau's hours of operation and available services;

Visit our Web site
www.portlandoregon.gov/bds

Note: All information in this brochure is subject to change.